

## » SR65 3AI

Wireless analogue input module

**thermokon**<sup>®</sup>  
HOME OF SENSOR TECHNOLOGY

### Datasheet

Subject to technical alteration  
Issue date: 14.01.2020 • A100



### » APPLICATION

The module has 3x 0..10 V inputs. The input values are transmitted wirelessly to an EasySens receiver. This allows standard analogue signals to simply integrate into a wireless EnOcean network.

### » SECURITY ADVICE – CAUTION



The installation and assembly of electrical equipment should only be performed by authorized personnel.

The product should only be used for the intended application. Unauthorised modifications are prohibited! The product must not be used in relation with any equipment that in case of a failure may threaten, directly or indirectly, human health or life or result in danger to human beings, animals or assets. Ensure all power is disconnected before installing. Do not connect to live/operating equipment.

Please comply with

- Local laws, health & safety regulations, technical standards and regulations
- Condition of the device at the time of installation, to ensure safe installation
- This data sheet and installation manual

### » NOTES ON DISPOSAL



As a component of a large-scale fixed installation, Thermokon products are intended to be used permanently as part of a building or a structure at a pre-defined and dedicated location, hence the Waste Electrical and Electronic Act (WEEE) is not applicable. However, most of the products may contain valuable materials that should be recycled and not disposed of as domestic waste. Please note the relevant regulations for local disposal.

### » PRODUCT TESTING AND CERTIFICATION



Declaration of conformity

The declaration of conformity of the products can be found on our website <https://www.thermokon.de/>.

## » TECHNICAL DATA

Radio technology	EnOcean (IEC 14543-3-10) EEP A5-3F-7F
Frequency	868 MHz
Power supply	15..24 V = (±10%) or 24 V ~ (±10%) SELV
Power consumption	typ. 0,2 W (24 V =)   0,4 VA (24 V ~)
Measuring interval	WakeUp time = 100 sec. (default), heartbeat cycle = 10x= every 10th. WakeUp
Inputs	3 analogue inputs, 0..10 V
Enclosure	PA6.6, pure white, cover PC transparent
Protection	IP65 according to EN 60529
Cable entry	M16 for cable with max. Ø=8 mm
Connection electrical	plug-in terminal, max. 1,5 mm <sup>2</sup>
Ambient condition	-25..+65 °C, max. 85% rH short term condensation
Weight	110 g

## » INFORMATION ABOUT EASYSSENS® (RADIO) / AIRCONFIG GENERAL USAGE



### EasySens® - airConfig

Basic information about EasySens® radio and about general usage of our airConfig software, please download from our website.

## » OVERVIEW OF THE RADIO TELEGRAMS



### EEP

The structure of the data contained in the telegram can be found in the EEP (EnOcean equipment profile) list provided by the EnOcean Alliance.

Offset	Size	Bitrange	Data	ShortCut	Description	Valid Range	Scale	Unit
0	8	DB3.7 ... DB3.0	Data Input 3	DI3	Data Input 3 linear	0 ... 255	0 – 10	V
8	8	DB2.7 ... DB2.0	Data Input 2	DI2	Data Input 2 linear	0 ... 255	0 – 10	V
16	8	DB1.7 ... DB1.0	Data Input 1	DI1	Data Input 3 linear	0 ... 255	0 – 10	V
24	4	DB0.7 ... DB0.4	Not Used (= 0)					
28	1	DB0.3	LRN Bit	LRNB	LRN Bit	Enum:		
						0: Teach-In Telegram		
						1: Data Telegram		
29	3	DB0.2 ... DB0.0	Not Used (= 0)					

## » MOUNTING ADVICES

The devices are supplied in an operational status. The module should be fixed to the smooth wall surface by means of rawl plugs and screws (accessory).

» CONNECTION PLAN

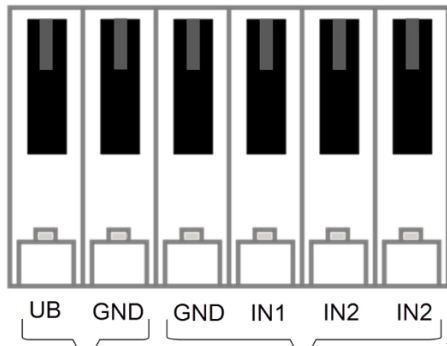

15..24 V = (±10%) | 24 V ~ (±10%)      0..10 V =

» CONFIGURATION UND COMMISSIONING

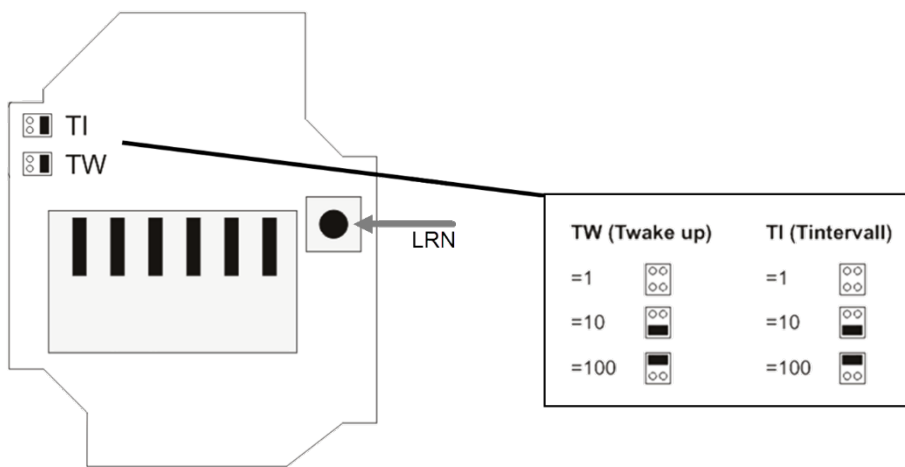

Factory default

T\_wake up: 100, T interval: 10  
 T\_send = 100 sec. Wake up x 10 interval = 1000 sec. = approx. 16 minutes

» DIMENSIONS (MM)

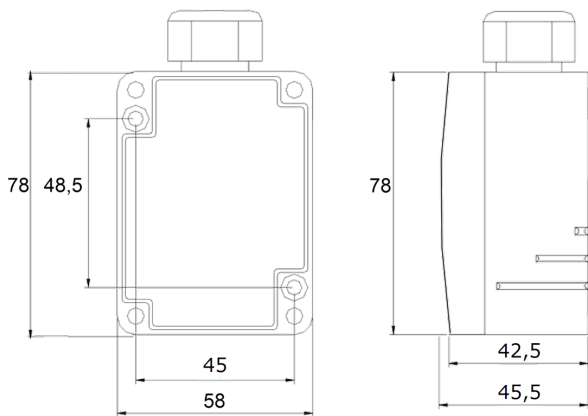

» ACCESSORIES (OPTIONAL)

Rawl plugs and screws (2 pcs. each)

Item No. 102209